

Contents

CONTACT INFORMATION	2
1. DECODER INSTALLATION/OPERATION	3
1.1 Installation of the decoder.....	3
1.2 Operating the decoder.....	5
1.2.1 Noise level.....	5
1.2.2 Signal Strength.....	5
1.2.3 Number of hits.....	5
1.2.4 Firmware update.....	6
1.3 Menu options explained.....	6
1.3.1 MENU: Timeline.....	9
1.3.2 MENU: General.....	11
1.3.3 MENU: Network.....	12
1.3.4 MENU: Dataserver.....	13

Appendices

APPENDIX A - FAQs.....	14
APPENDIX B - CE AND FCC REGULATIONS.....	17
APPENDIX C - TECHNICAL SPECIFICATIONS.....	18
APPENDIX D - AUXILIARY CONNECTIONS.....	19
GUARANTEES & WARRANTIES.....	21

Figures

Figure 1.1 System overview.....	3
Figure 1.2 Connections of the decoder.....	4
Figure 1.3 Status display.....	6
Figure 1.4 Decoder with status display.....	7
Figure 1.5 Menu.....	9
Figure 1.6 Holdoff time.....	10
Figure 1.7 Connecting photocells, connection setup.....	20

Contact Information

MYLAPS EMEA Office Haarlem

Haarlem
The Netherlands
Tel: +31 23 529 1893
E-mail: info@mylaps.com

MYLAPS Americas Office

Atlanta
USA
Tel: +1 (678) 816 4000
E-mail:
info.americas@mylaps.com

MYLAPS Japan Office

Tokyo
Japan
Tel: +81 3 5275 4600
Email:
info.japan@mylaps.com

MYLAPS Asia Pacific Office

Sydney
Australia
Tel: +61 (0)2 9546 2606
Email:
info.asia.pacific@mylaps.com

www.mylaps.com



All rights reserved

Copyright © 2005-2010 MYLAPS (formerly AMB i.t.)

This publication has been written with great care. However, the manufacturer cannot be held responsible, either for any errors occurring in this publication or for their consequences.

The sale of products, services of goods governed under this publication are covered by MYLAPS's standard Terms and Conditions of Sales and this product manual is provided solely for informational purposes. This publication is to be used for the standard model of the product of the type given on the cover page.

MYLAPS

Manual: MYLAPS Decoder/01-2010

1: Decoder Installation/Operation

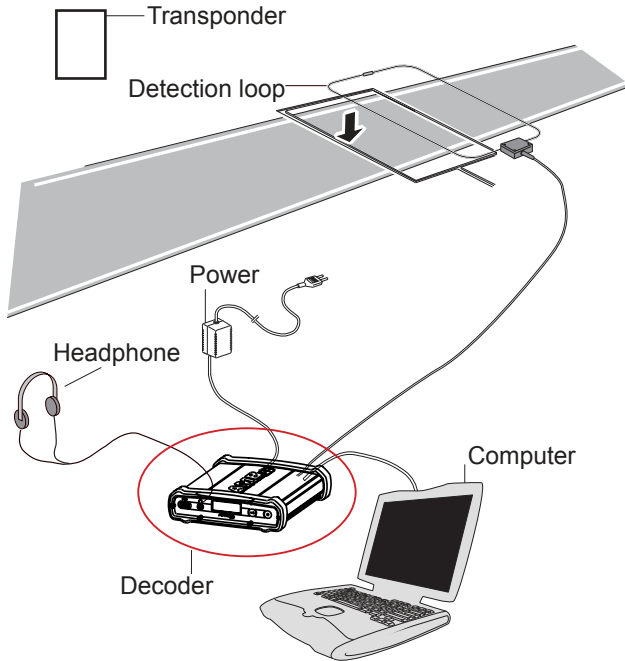

Figure 1.1 System overview

1.1 Installation of the decoder

The MYLAPS decoder is a precision instrument. Therefore please handle it with care and keep the decoder out of direct sunlight and avoid high humidity. Take special precautions in case of thunderstorms by disconnecting all cables (coax, Ethernet and mains) from the MYLAPS decoder. Nearby lightning strikes can damage the decoder when these cables are connected.

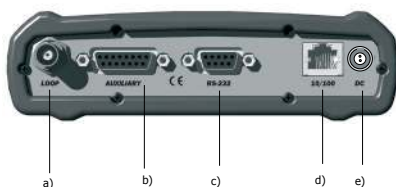

Figure 1.2 Connections of the decoder

How to connect

- a) The detection loop: Connect the supplied 75 Ohm double-shielded coax cable to the decoder.
- b) The auxiliary port: This port can be used to connect a photocell, external start pulse or a sync pulse. For more information on how to connect these devices, see appendix D.
- c) The serial port: This port can be used to connect the decoder with the computer through a RS232 cable.
- d) The network: This port can be used to connect the network cable between the decoder and the network connection port of the computer.
- e) Power: Connect the supplied VDC adapter to the decoder and mains. It is recommended to connect the VDC adapter to mains through a UPS (Uninterruptable Power Supply) to avoid any interruption of power supply to the decoder.
- f) The headphone: Connect it on the **front side** of the decoder. A beep will sound for every passing transponder, which provides an easy check for proper operation of the decoder and the transponders on the track.

1.2 Operating the MYLAPS decoder

The decoder is not equipped with an on/off switch, therefore connecting the decoder to the mains will switch it on. This will enable timing of transponder passings after approximately 15 seconds. With each detection of a transponder, a beep will sound in the headphone and received transponder information is shown on the decoder display.

1.2.1 Noise level

The decoder determines the average background noise. The noise (and signal strength) has a range of 0 to 255 points. Noise level, as shown by the AMB i.t. timing software and also on the decoder screen, should not exceed 40 points. If the noise level is higher, the received transponder signal strength should be 60 points above noise level to ensure proper functioning of the system. So if the transponder received signal strength is 120 points, the noise should not exceed 60 points.

1.2.2 Signal strength

Transponder signal strength, as shown by the AMB i.t. timing software, should preferably be above 100 points and should at least be 60 points higher than the indicated background noise. The closer the transponder is to the track, the higher the received signal strength will be. A higher transponder signal strength should allow for greater immunity against outside interference.

1.2.3 Number of hits

The number of hits, as shown by the AMB i.t. timing software, is an indication of the number of repeated transponder signal receipts during a passing. Hit-rates vary with the speed of a passing transponder. Slower passings yield higher hit counts. Usually the number of hits is greater than 10.

1.2.4 Firmware update

We constantly strive to improve all our products. For new functionalities and minor changes you can check our website for a MYLAPS decoder firmware update. Please go to the support section of the www.mylaps.com website and follow the instructions found there to download and install updated firmware as applicable.

1.3 Menu options explained

On the front of the decoder, you will find an information display designed to view and change the decoder settings.

The status screen will show the following information:

- a: Decoder date/time, UTC when synchronized to GPS
- b: Timeline name
- c: Blinks when connecting to Mylaps Practice, steady when connected to Mylaps Practice
- d: Background noise indication
- e: Indication that hits are received, remains black when a transponder is being received by the loop
- f: Strength of last received transponder
- g: Number of received GPS satellites
- h: Blinks when GPS receiver attached, steady when decoder is locked to UTC time
- i: Message line

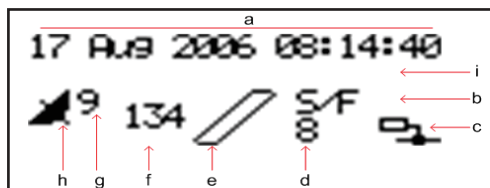

Figure 1.3: Status display

By clicking on the acknowledge button you will cycle through the status screens:

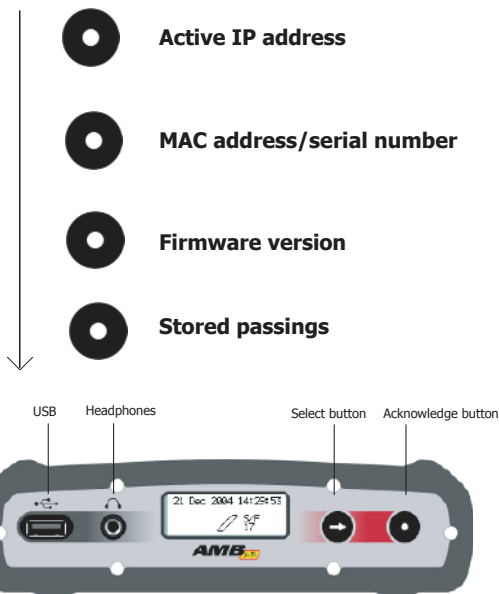

Figure 1.4: Decoder with status display

By clicking on the Select and Acknowledge buttons you can choose which information you want to see on the display. Detailed information of the menu options will be given on the following pages. The "Select" button will highlight the next option on the menu when pressed. The "Acknowledge" button will either open the highlighted sub-menu or select the highlighted option, depending on the situation.

By clicking on the select button you will find a main menu menu with different subjects :

Timeline	Name
	Index
	Main/backup
	Sport*
	Squelch
	Gatetime**
	Loop Trigger***
	Auxiliary* - Photo holdoff - Ext. start holdoff - Sync holdoff

General	Clear passings
	Clock - Date - Time
	Beep
	First contact*
	Protocol RS232
	Contrast
	Factory defaults
	Firmware

Network	Automatic
	IP address
	Subnet mask
	Gateway
	DNS

Dataserver	Enabled	
	Host	* <i>only available for ChipX decoder</i>
	Port	** <i>only available for TranX3 and AMBmx3 decoder</i>
	MyLaps Practice code	*** <i>only available for TranX3 and ChipX decoder</i>

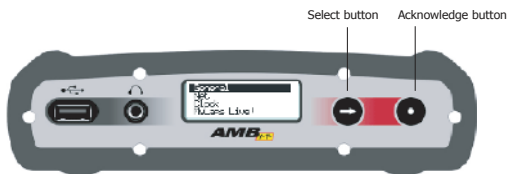

Figure 1.5: Menu

You can navigate between the menu items with the Select button and you can choose an option with the Acknowledge button. Please note that you can go one step back by selecting << and clicking the Acknowledge button.

1.3.1 MENU: Timeline

Within the timeline menu you can choose/see:

- **Name, Index, Main/Backup:**

With these settings you can define the role of the decoder. The settings do not influence the decoder performance but can be retrieved by the software for easier track setup. If multiple intermediate points are used the Index can be used to set the order of the intermediate points.

- **Sport:** *only available for the MyLaps ProChip decoder*

There are many parameters which may influence timing performance. With the sport setting the decoder uses some pre-defined parameters optimized for a certain type of sport / transponder placement.

Sport	Loopwidth	Transponder placement
Ice skating	50cm / 1.7ft	Strap around ankle
Inline skating	60cm / 2ft	Strap around ankle
Cycling	60cm / 2ft	Vertically mounted to the bike 
Other	60cm / 2ft	

Note : Use 'other' if there is no **exact** match for sport and transponder placement.

- Squelch:

With the squelch setting you can suppress weak transponder signals. This is sometimes useful if participants are walking near the loop or the coaxial cable and are picked up accidentally. E.g. if the squelch setting is set to 60, all transponders with received strength below 60 will be ignored.

- **Gate time:** *only available for MYLAPS Car/Bike/Kart and MYLAPS MX decoder*
- **Loop trigger:** *only available for MYLAPS Car/Bike/Kart and MYLAPS ProChip decoder*
Optional for future developments.
- **Auxiliary:** *only available for MYLAPS ProChip decoder*

Photo holdoff, External start holdoff, Sync holdoff. This is the time in milliseconds the decoder will wait before accepting a new pulse via one of those inputs. At the start of the pulse the holdoff period will be active. During the holdoff period all other signals will be ignored.

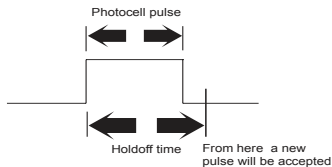

Figure 1.6 Holdoff time

1.3.2 MENU: General

Within the general menu you can choose/see:

- **Clear passings:**

Enables you to clear the passings in the flash memory.

- **Clock:**

Date: Here you can change the date.

Time: Here you can change the time of day.

To set your decoder to a specific time in seconds: First select the time in hours and minutes that you wish to set the decoder on. After this, the decoder will ask you to select SET. At the exact moment SET is selected, the decoder clock will start at the selected time from zero seconds. For example: the new time setting for the decoder is 11.15; when you press SET, the decoder clock will start counting at the exact time, 11h:15m:00s.

- **Beep:**

Choose the tone of the beep.

- **First contact:** *only available for MYLAPS ProChip decoder*

When switched on, the decoder will send a record without a time stamp instantly as the transponder is detected. This is intended to allow TV graphics applications to display competition information at first detection, allowing the passing time to be displayed after the competitor exits the detection field and passing time is determined. Note: this option is enabled only in the P3 protocol.

- **Protocol RS232:**

This is used to select the protocol on the RS232 interface. There are 3 options:

Enhanced - This protocol is here only for compatibility reasons. Not all features are available via this protocol.

P3 - If you are a software developer this is the preferred protocol to use. This protocol is also used for software like 'Racewave'.

Remote - Allows the host computer to select the protocol by using a command. Use this setting when

used with Orbits.

- Contrast:

Contrast of the display - Here you can adjust the contrast settings.

- Factory defaults:

Reset to the factory defaults - You can reset the settings of the decoder to the initial settings.

- Firmware:

Software running inside the decoder - When you update the firmware in your decoder, the decoder will retain the current version of the firmware. With the switch firmware option you are able to revert back to the previous version.

1.3.3 MENU: Network

Please leave the decoder in the automatic menu if you are not familiar with network basics. Within the Network menu you can choose/see:

- Automatic:

To automatically determine the IP address of the decoder. If your decoder is placed in a network and you select automatic "on" the decoder will first try via the DHCP server (DHCP = Dynamic Host Configuration Protocol) to get an IP address which is in the range of the network. Please note that it can take about 60 sec. to obtain the settings via DHCP. If a DHCP server is not found, the decoder will use an IP address via APIPA (Automatic Private IP Addressing).

- IP address:

IP address of your decoder - An identifier for a computer or device on a TCP/IP network.

- Subnet mask:

A mask used to determine what subnet an IP address belongs to.

- Gateway:

A node on a network that serves as an entrance to another network.

- DNS:

Short for Domain Name System (or Service or Server), an Internet service that translates domain names into IP addresses. Gateway and DNS are both used to set up the decoder for Mylaps live.

1.3.4. MENU Dataserver

This function enables the decoder to contact a server to upload data to. Contact MYLAPS Sports Timing for more details. Within the server menu you can see/change:

- Enabled:

Live upload to a data server is enabled.

- Host:

Host name or IP address of a server to upload data to.

- Port:

TCP/IP port where the server receives the data

- MyLaps practice code:

A unique code which should be used for registering on MyLaps Practice website (www.mylaps.com/practice). Please visit MyLaps.com for more information about online race results.

Note:

For accessing server functionality you need a functioning internet connection. Also, the DNS server and gateway setting must be correctly configured (see menu Network).

A1: Transponder is not being detected

A few transponders are not being detected.

If this is the case, the problem is most likely related to the individual transponder or the positioning of the transponder.

- Check the mounting position of the transponder, for more information check your transponder manual.

None of the transponders are being detected.

If this is the case, the problem is most likely related to the detection loop, decoder, timing computer or cabling. Please take the following steps:

- Check if a beep is heard in the headphone, or if the loop in the display changes to black during a transponder passing. If this is working, but nothing appears on the computer screen, check the cabling between the decoder and the computer.
- Check the coaxial cable by measuring the resistance (with multimeter) between the center pin and the outside of the BNC connector. The reading should be approximately 150 kOhm (for MYLAPS ProChip decoders) and 100 kOhm (for other types of decoders) after 30 seconds. If not, the coaxial must be replaced.
- Check the loop wire by cutting the loop wires from the connection box and measuring the resistance between the loop wires in the track. The reading should be approximately 220 Ohm (for MYLAPS ProChip decoders) and 470 Ohm (for other types of decoders). If this is not the case, the loop must be replaced. When (re)connecting the loopwires to the connection box please solder with proper connections (for more information please check your system installation manual).

Error messages

- Activator overload:
This means that the overcurrent protection of the activation circuit is working. A possible cause is a short circuit in the coaxial cable, or the use of an incorrect loop or connection box.
- Activator hot:
This means that the temperature of the activator circuit is too high. The decoder must be used at ambient temperatures below 50C/122F, otherwise problems with the loop may occur.

A2: Noise level

What if my background noise is higher than 40 points?

An increased background noise is an indication of a higher interference level picked up by the system. Every five seconds, a background noise measurement is performed by the decoder and sent to the computer. The noise level should be as low as possible, but as long as the received signal from the transponders is at least 60 points higher than the noise level detection will be reliable. If the noise level is higher than 70, then there is most likely something wrong with the installation.

Possible causes of high background noise levels:

- When the detection loop is damaged, a fluctuation in noise level will be noticeable, especially in wet conditions. If this is the case, please check the loop wire and coaxial for cuts or breakage.
- Electrical equipment too close (<3 m) to the loop or coaxial cable.
- Using a generator with a poor ground connection
- Use of DC/AC converter for AC power.
- Poor connections between the detection loop and the coaxial cable.

- BNC connector incorrectly fitted to the coaxial cable.
- Poor ground connection of the AC power. If this is the case, ground the decoder by connecting the outside of the BNC connectors on the decoder to a piece of metal (copper rod or tube) that is in a fixed connection with the ground.

A3: Signal strength

What if the received signal strength is below 100 points?

- If the signal strength is lower than 100 points, please check the position of the transponder.
- If the signal strength is fluctuating heavily in combination with high noise levels, check the quality of the loop installation and coaxial cables.

Appendix B: CE and FCC Regulations



CE information:

This device complies with the EMC directive 89/336/EEC. A copy of the declaration of conformity can be obtained at:

MYLAPS Sports Timing
Zuiderhoutlaan 4
2012 PJ Haarlem
The Netherlands



FCC information:

This equipment complies with part 15 of the FCC rules. Operation is subject to the following two conditions: (1) This equipment may not cause harmful interference, and (2) this equipment must accept any interference received, including interference that may cause undesired operation.

Appendix C: Technical Specifications

Dimensions	180 x 160 x 45 mm / 7 x 6.3 x 1.8 in
Weight	720 g / 1.6 lb
Decoder Clock stability	0.5 ppm
Decoder Timing Resolution	0.001 s
Time of day clock stability (decoder off)	+/- 25 ppm
Time of day clock stability (decoder on)	+/- 0.5 ppm
Time of day clock resolution	1 sec.
Time of day clock synchronisation	via GPS receiver to UTC
Max. track width	max. 20 m / 66 ft
Operating temperature range	-20 to 50 C / -4 to 122 F
Humidity range	10 % to 90 % relative
Operating voltage range	10 to 14.4 V, typical 12V
Power consumption	max. 650 mA @ 12V, typical 500 mA
Interfaces	RS232, 9600 baud, 8 bits, 1 stopbit 10/100 BaseT USB A
Network connection	DHCP client, APIPA, Static IP
Aux. Power	5 VDC, max 100 mA
Aux. Output	Opto coupled closing contact max 50 mA switched
Aux. Inputs	3x Opto coupled 5-12 VDC / 5-15 mA

Specifications are subject to change without notice.

Appendix D: Auxiliary connections

The MYLAPS decoder is equipped with an auxiliary port (15 pin sub D-connector). The auxiliary port has 3 inputs, photo cell 1, photo cell 2, sync pulse and a control port for a GPS receiver. All inputs can be triggered by a 5 VDC (5-15 mA) pulse. Figure 1 explains the connection setup. To use a photocell, connect it using the MYLAPS photocell cable or make an appropriate cable using figure 1 below. Two types of photocells are available, passive and active photocells. They both operate as a switch; to connect the passive photocells please follow the connection setup in figure 1a and scheme 1b. Active photocell can be connected directly to the photocell/sync – and + input pins.

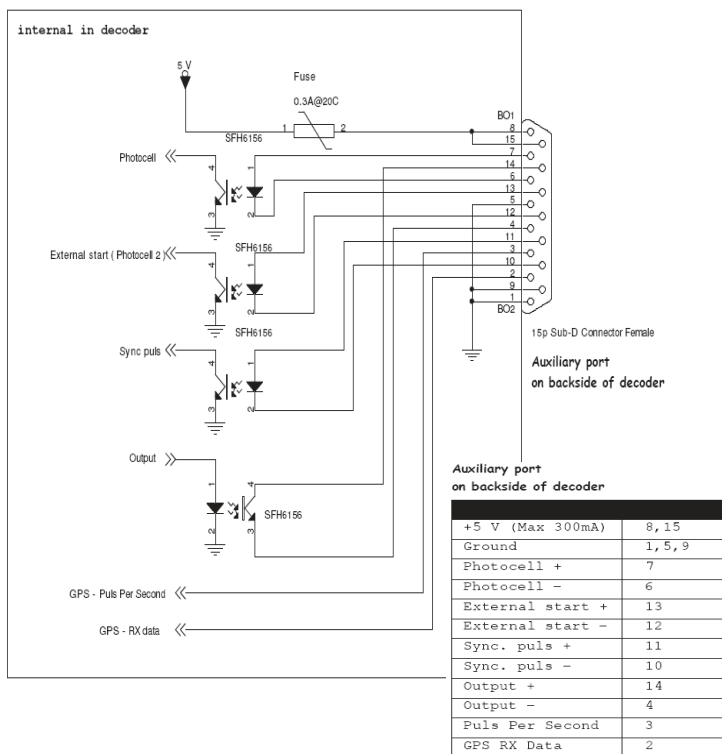

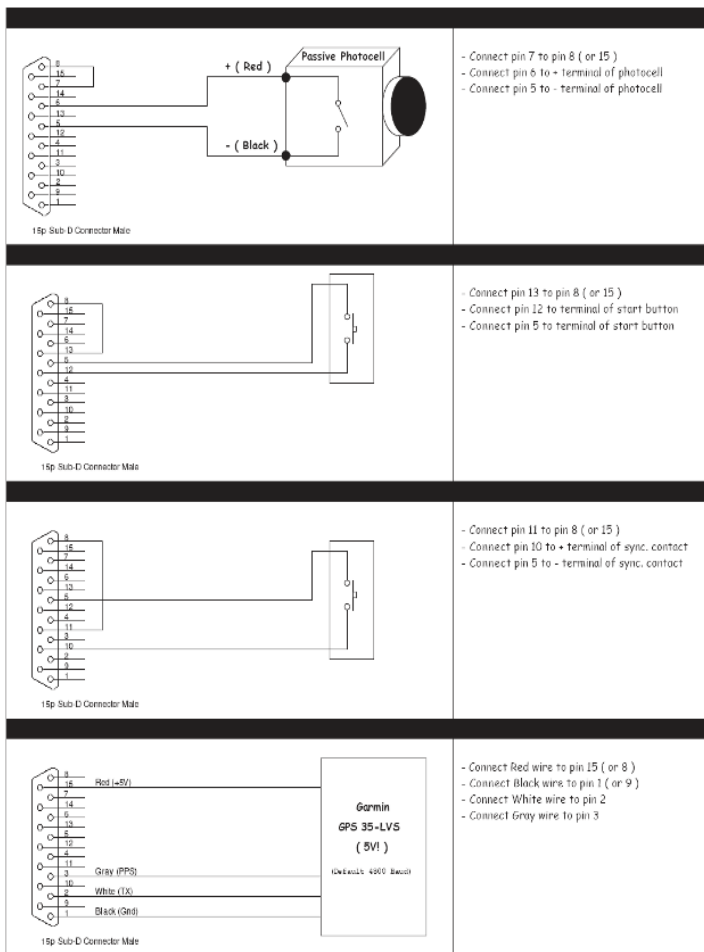

Figure 1.7: Connecting photocells, connection setup

Guarantees & Warranties

MYLAPS, formerly AMB, warrants that, for a period of three (3) years from the date of shipping the decoders and the MYLAPS MX Rechargeable Power (AMBmx), MYLAPS RC DP (AMBrc DP), MYLAPS KART DP (TranX160 DP), MYLAPS Kart Rechargeable Power (TranX160), MYLAPS Car/Bike DP (TranX260 DP), MYLAPS Car/Bike Rechargeable Power (TranX260), MYLAPS Car/Bike Pro (TranX Pro) transponders covered by this warranty with defects, as determined solely by MYLAPS, caused by faulty materials, workmanship or design will be repaired or replaced, unless such defects were the result of any of the following: shipping; improper installation, maintenance or use; abnormal conditions of operation; attempted modification or repair by the customer or any third party; use of the goods in combination with other items; or an act of God. If repair or replacement of the goods is not possible or economical for MYLAPS, MYLAPS may, at its option, refund the purchase price of the goods or deliver replacement goods at its sole discretion. MYLAPS's liability shall be strictly limited to replacing, repairing or issuing credits at its option.

MYLAPS warrants that, for a period of two (2) years from the date of shipping the ProChip, MYLAPS Kart Fixed Power (TranX140) and the MYLAPS RC Rechargeable Power (AMBrc) transponders covered by this warranty with defects, as determined solely by MYLAPS, caused by faulty materials, workmanship or design will be repaired or replaced, unless such defects were the result of any of the following: shipping; improper installation, maintenance or use; abnormal conditions of operation; attempted modification or repair by the customer or any third party; use of the goods in combination with other items; or an act of God. If repair or replacement of the goods is not possible or economical for MYLAPS, MYLAPS may, at its option, refund the purchase price of the goods or deliver replacement goods at its sole discretion. MYLAPS's liability shall be strictly limited to replacing, repairing or issuing credits at its option.

MYLAPS warrants that, for a period of one (1) year from the date of shipping the MYLAPS Onboard Display kit (TnetX Display Kit) covered by this warranty with defects, as determined solely by MYLAPS, caused by faulty materials, workmanship or design will be repaired or replaced, unless such defects were the result of any of the following: shipping; improper installation, maintenance or use; abnormal conditions of operation; attempted modification or repair by the customer or any third party; use of the goods in combination with other items; or an act of God. If repair or replacement of the goods is not possible or economical for MYLAPS, MYLAPS may, at its option, refund the purchase price of the goods or deliver replacement goods at its sole discretion. MYLAPS's liability shall be strictly limited to replacing, repairing or issuing credits at its option.

MYLAPS warrants that, for a period of one (1) year from the date of shipping, all other goods covered by this warranty with defects, as determined solely by MYLAPS, caused by faulty materials, workmanship or design will be repaired or replaced, unless such defects were the result of any of the following: shipping; improper installation, maintenance or use; abnormal conditions of operation; attempted modification or repair by the customer or any third party; use of the goods in combination with other items; or an act of God. If repair or replacement of the goods is not possible or economical for MYLAPS, MYLAPS may, at its option, refund the purchase price of the goods or deliver replacement goods at its sole discretion. MYLAPS's liability shall be strictly limited to replacing, repairing or issuing credits at its option.

If the requirements set forth above and described under Remedies and Damages are not complied with, our warranty/guarantee shall not apply and we shall be discharged from all liability arising from the supply of defective goods.

EXCEPT AS EXPRESSLY PROVIDED IN THIS SECTION, MYLAPS MAKES NO REPRESENTATIONS OR WARRANTIES OF ANY KIND, NATURE OR DESCRIPTION, EXPRESS OR IMPLIED, INCLUDING WITHOUT LIMITATION, ANY WARRANTY OR MERCHANTABILITY, FITNESS OF THE GOODS FOR ANY PARTICULAR PURPOSE, OR NONINFRINGEMENT, AND MYLAPS HEREBY DISCLAIMS THE SAME.

Remedies and Damages

1. MYLAPS shall not incur any liability under the above warranty unless:
 - i) MYLAPS is promptly notified in writing upon discovery by the customer that such goods do not conform to the warranty, and the appropriate invoice number and date of purchase information is supplied;
 - ii) The alleged defective goods are returned to MYLAPS carriage pre-paid;
 - iii) Examination by MYLAPS of goods shall confirm that the alleged defect exists and has not been caused by unauthorized use (including, without limitation, the use of an AMB decoder with non-MYLAPS hardware) misuse, neglect, method of storage, faulty installation, handling, or by alteration or accident; and
 - iv) With respect to MYLAPS decoders, customer has upgraded the firmware in its decoder within one month after MYLAPS has offered to provide customer with such upgraded firmware.
2. The customer acknowledges that the goods may include certain firmware imbedded therein. MYLAPS hereby grants a license to customer to use the imbedded firmware in an MYLAPS decoder, but only to the extent the decoder is used in connection with MYLAPS hardware. MYLAPS shall have the right to terminate the license immediately upon written notice to customer in case MYLAPS has a reasonable belief that customer at any time has used the MYLAPS decoder in connection with non-AMB hardware. Further, customer may not copy, compile, reverse compile, disassemble, translate, analyze, reverse engineer or attempt to reverse engineer the firmware, except as permitted by applicable law.
3. In addition, customer grants MYLAPS the option to repurchase any MYLAPS decoder if MYLAPS has a reasonable belief that customer has used the MYLAPS decoder in connection with non-MYLAPS hardware. The repurchase price shall be the fair market value on the date MYLAPS provides notice to customer that it intends to repurchase the decoder.

The above mentioned warranty/guarantee is irrespective of any rights granted to the buyer of MYLAPS equipment manufactured or sold by MYLAPS based on the laws of the Netherlands. Any correspondence regarding the above mentioned guarantee must be addressed to MYLAPS:

MYLAPS EMEA OFFICE HAARLEM
Zuiderhoutlaan 4
2012 PJ HAARLEM
THE NETHERLANDS
E-mail: info@mylaps.com
Fax: +31 23 529 0156